

Bridge Amplifier for Strain Gage Full Bridge

DABI AD2T-FB

Features

- Industrial bridge amplifier for S/G full bridge
- For cyclical and static applications with reset function
- Current output
- Protection class IP 65
- Analog signal path



Electrical Data

Output signal	4 - 20 mA calibrated	
Characteristic curve deviation	0.25 < 0,5%	1.00 < 0,2%
	0.50 < 0,25%	2.00 < 0,2%
Supply voltage range	14 - 33 VDC	
Current draw	< 90 mA	
	< 70 mA @ 24 VDC	
Bridge excitation	approx. 7 VDC	
S/G bridge resistance	≥ 350 Ω	
Burden	< 500 Ω	
Tare accuracy	0.25 < 30 μA	
	0.50 < 20 μA	
	1.00 < 16 μA	
	2.00 < 16 μA	
Reset input	active	5 - 33 VDC < 2 mA
	inactive	< 1 VDC
Tare range	±6 mV/V	
Reset puls	> 1 ms	
Reset settle time	< 5 ms	
Frequency range (-3 dB)	1'000 Hz	
Noise	(0 ... 5 kHz)	
	0.25 < 15 μA _{pp}	
	0.50 < 7,5 μA _{pp}	
	1.00 < 5 μA _{pp}	
		2.00 < 5 μA _{pp}

Mechanical Data

Control connection	5 pin male (Series 713)
Sensor connection	4 pin female (Series 712)
Enclosure	aluminum anodised

Environmental Conditions

Operating temp. range	-25...+85 °C
Specified temp. range	0...+70 °C
Storage temperature	-40...+100 °C
Protection class	IP 65
EMC	EN 61000-6-2 Immunity
	EN 61000-6-3 Emission

Order Code

DABI AD2T-FB

Gain

0.50	0,50 mV/V = 4 - 20 mA
1.00	1,00 mV/V = 4 - 20 mA
2.00	2,00 mV/V = 4 - 20 mA

Dimensions (mm)

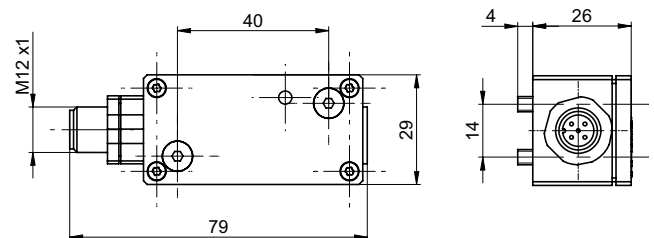

Delivery Contents

- Mounting screw 2 pcs. M4 x 30

Accessories (not included in delivery)



Series 713

Connector female, control side, 5-pin, Part No. 10135462
max. cable length 20 m

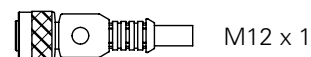

M12 x 1

Connector female with cable, control side, 5-pin

ESG 34CH0200G 5-pin (shielded) 2 m, PUR,
(Part No. 11046264)

ESG 34CH0500G 5-pin (shielded) 5 m, PUR,
(Part No. 11046266)

ESG 34CH1000G 5-pin (shielded) 10 m, PUR,
(Part No. 10155587)

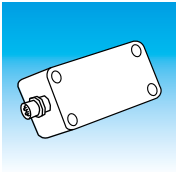

Electrical Connection

Sensor side Series 712

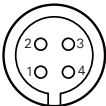

Pin	Signal
1	Full bridge EXC.+
2	Full bridge SIG.-
3	Full bridge SIG.+
4	Full bridge EXC.-

Control side Series 713



Pin number	Signal
1	+Vs
2	n.c.
3	GND
4	+I _{OUT}
5	Reset

S/G Bridge

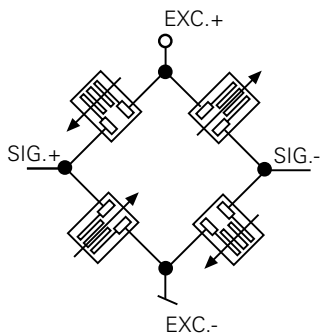

Control

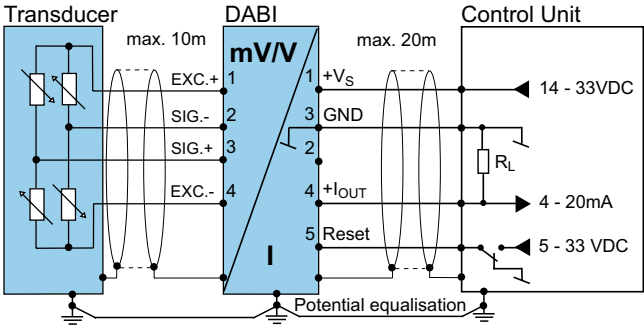

Reset Function

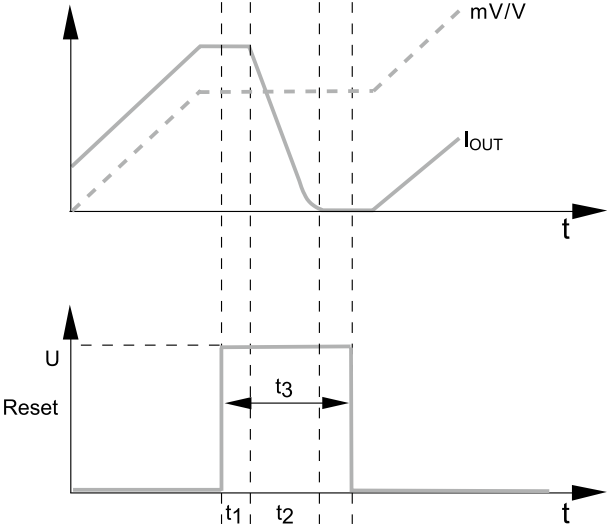

I _{OUT}	Output signal
mV/V	Input signal
Reset	Reset input (active high)
t ₁	Reset delay (< 0,3 ms)
t ₂	Reset time (< 5 ms)
t ₃	Reset impuls (> 1 ms)